

MAINTENANCE-FREE BATTERY GEL VRLA VPRO PREMIUM 110Ah 12V

INDEKS: 6AKUGEL110
EAN: 5903760240677

GEL VPRO PREMIUM batteries by **VOLT POLSKA** are designed with special separator and GEL deep cycle technology to give extra-durable cyclic performance at extreme temperature. **The general features are:** safety sealing, long life and low self-discharge design, non-spillable construction, high reliability and stability, sealed and maintenance-free, safety and quality certification. **GEL VPRO PREMIUM batteries** have 12 years design life at 25°C. They can be applied in emergency power system, communication equipment, telecommunication systems, marine equipment, uninterruptible power supplies, solar and wind power system.

Main technical data:

Nominal voltage		12 V
Rated capacity		110 Ah
Dimension	total height	218 mm
	height	213 mm
	width	173 mm
	length	331 mm
Approx Weight		28.6kg (63.05lbs) +/- 3%
Gross dimensions		36,4x20,3x26,5cm
Gross weight		29,1kg

Other specification:

Capacity (at 25°C)	10h (10,8V)	110 Ah
	5h (10,5V)	80 Ah
	3h (10,5V)	73,5 Ah
	1h (9,6V)	55 Ah
Internal Resistance		~ 3,5 mΩ
Capacity affected by temperature	40°C	102%
	25°C	100%
	0°C	85%
	-15°C	65%
Self discharge (at 25°C)	3 months	91%
	6 months	82%
	12 months	64%
Working temperature		25°C +/- 3°C
Working temperature	Discharge	-15°C do 50°C
	Charge	-10°C do 50°C
	Storage	-20°C do 50°C
Float Use (25°C)	13,5 VDC	13,8 VDC
Cycle Use (25°C)	14,4 VDC	14,7 VDC
Max charging current		20 A
Max discharge current		800A (5 s)
Design life (25°C)		12 years

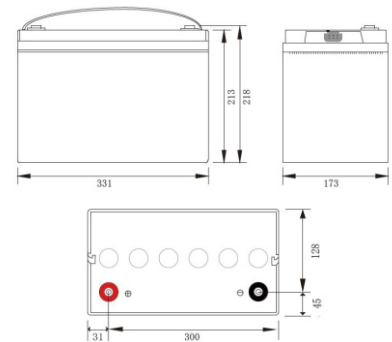

Dimension

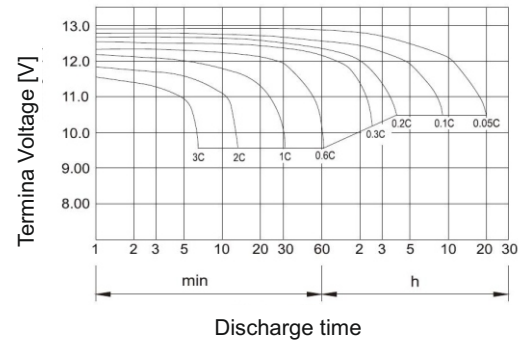

Discharge characteristic curve at 25°C

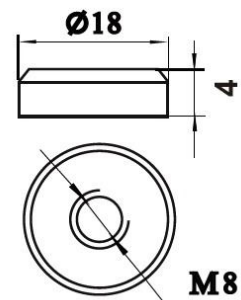

Terminal type (mm):